

Introduction to 8086 Assembly

Lecture 2

80x86 architecture, registers and basic assembly



1928

K. N. Toosi University of Technology

Intel 8086 microprocessor

- released in 1978
- 16 bit
- The x86 Architecture

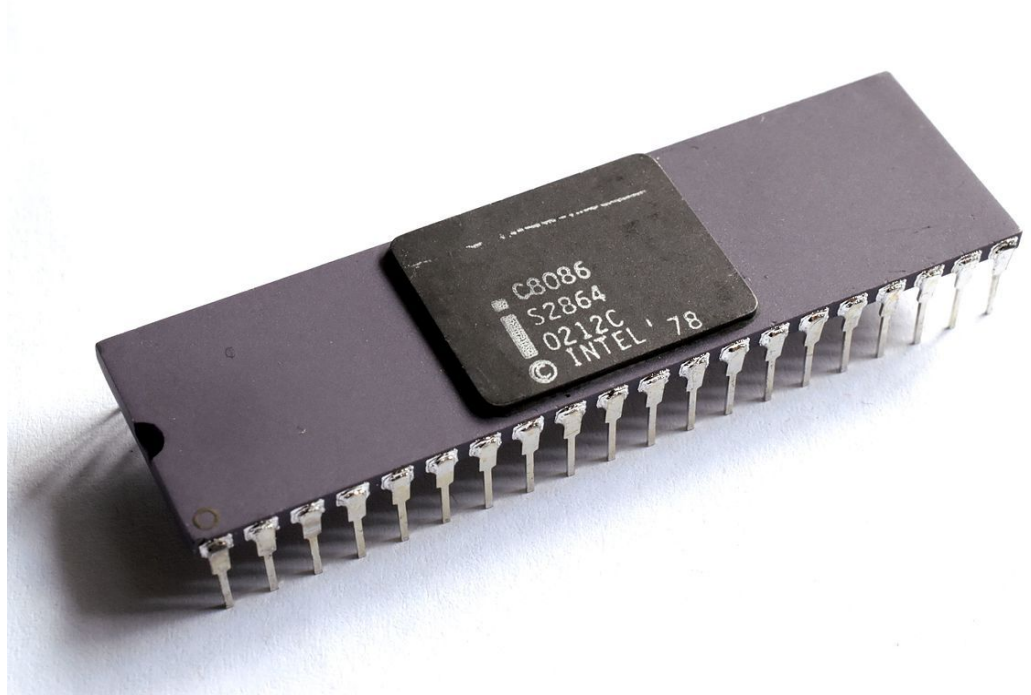

https://en.wikipedia.org/wiki/Intel_8086

CPU, Memory, instructions and data



1928

K. N. Toosi University of Technology

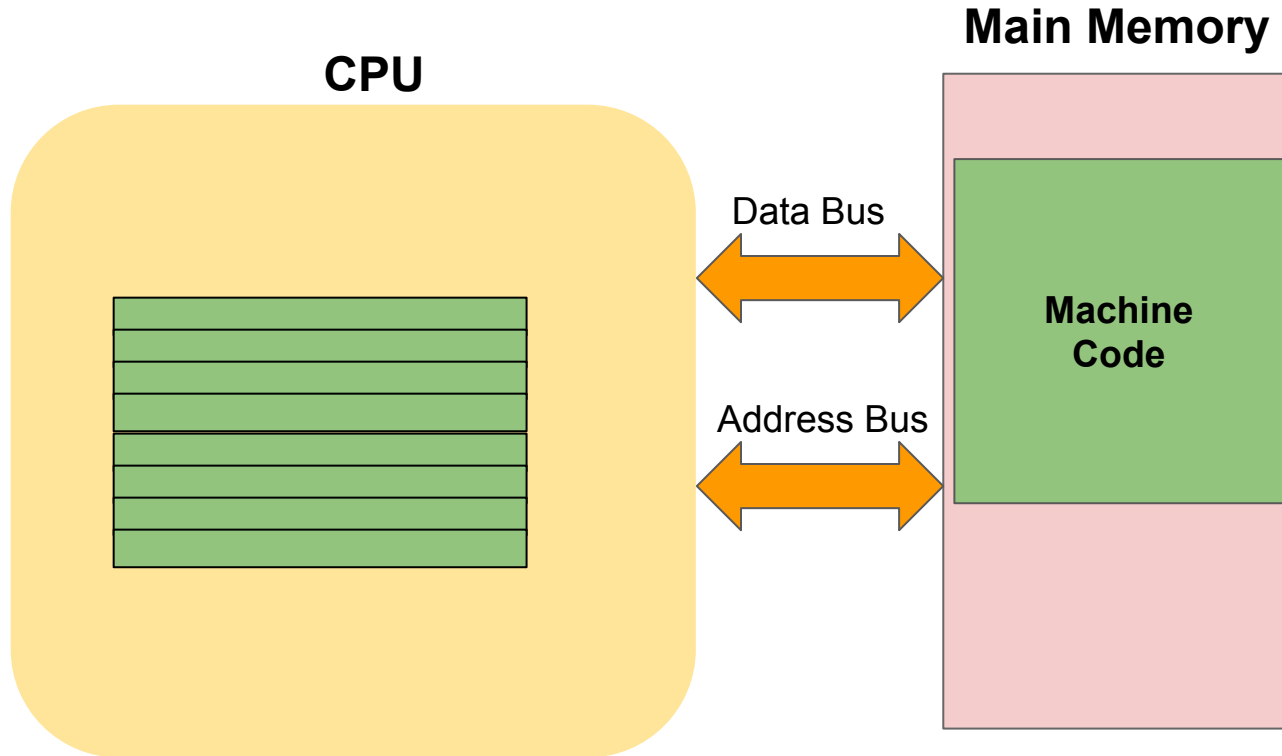

CPU, Memory, instructions and data



1928

K. N. Toosi University of Technology

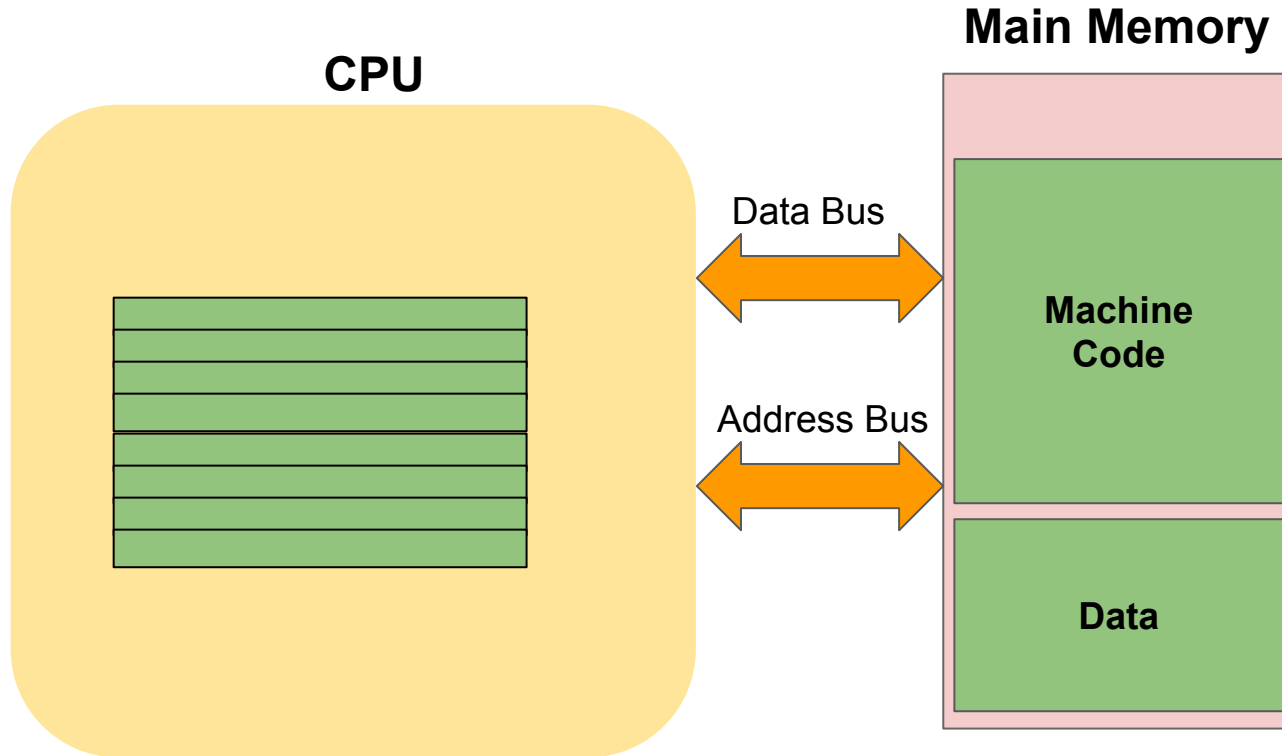

Intel 8086 architecture



1928

K. N. Toosi University of Technology

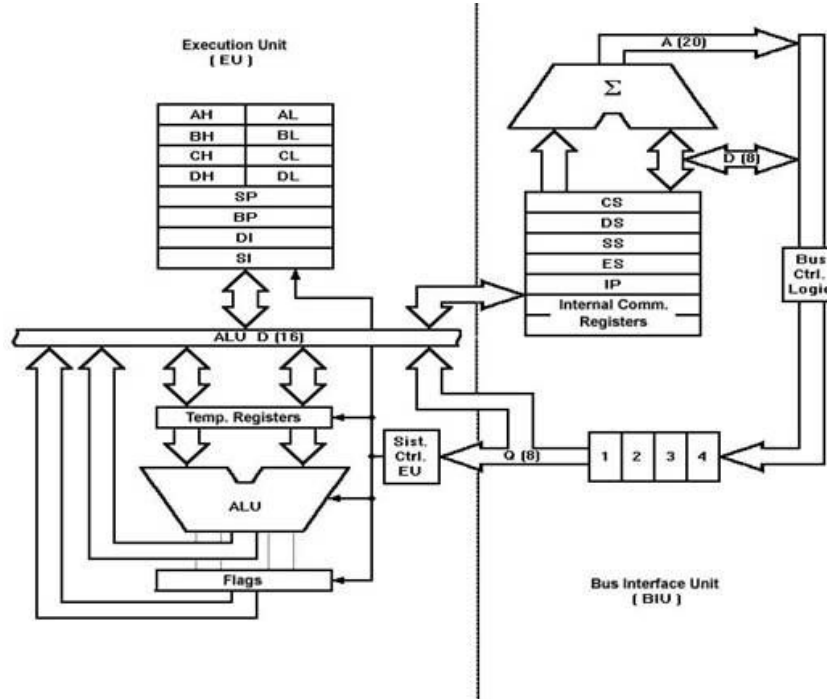

http://www.cosc.brocku.ca/~bockusd/3p92/Local_Pages/8086_architecture.htm



1928

University of Technology

Intel 8086 registers

- 16 bit registers
- 8 bit access
 - AX, BX, CX, DX
 - e.g. AX = (AH | AL)

General Purpose Registers

AX	AH	AL	Accumulator
BX	BH	BL	Base
CX	CH	CL	Count
DX	DH	DL	Data

Pointer and Index Registers

SP		Stack Pointer
BP		Base Pointer
SI		Source Index
DI		Destination Index
IP		Instruction Pointer

Segment Registers

CS		Code Segment
DS		Data Segment
SS		Stack Segment
ES		Extra Segment

--

 Flags

<http://bucarotechelp.com/computers/architecture/86011201.asp>



1928

University of Technology

Intel 8086 assembly syntax

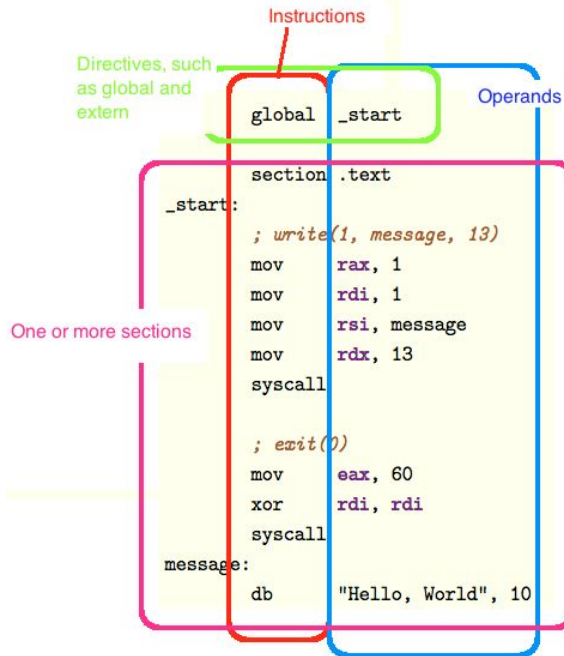

General Purpose Registers

AX	AH	AL	Accumulator
BX	BH	BL	Base
CX	CH	CL	Count
DX	DH	DL	Data

Pointer and Index Registers

SP		Stack Pointer
BP		Base Pointer
SI		Source Index
DI		Destination Index
IP		Instruction Pointer

Segment Registers

CS		Code Segment
DS		Data Segment
SS		Stack Segment
ES		Extra Segment

Flags

<http://cs.lmu.edu/~ray/notes/nasmtutorial/>

<http://bucarotechelp.com/computers/architecture/86011201.asp>



1928

University of Technology

Intel 8086 assembly commands

```
mov x,y  
xchg x,y
```

```
inc x  
dec x
```

```
add x,y  
sub x,y  
neg x
```

; bitwise operators

```
and x,y  
or x,y  
xor x,y  
not x
```

x, y: register, constant, memory (address)

General Purpose Registers

AX	AH	AL	Accumulator
BX	BH	BL	Base
CX	CH	CL	Count
DX	DH	DL	Data

Pointer and Index Registers

SP		Stack Pointer
BP		Base Pointer
SI		Source Index
DI		Destination Index
IP		Instruction Pointer

Segment Registers

CS		Code Segment
DS		Data Segment
SS		Stack Segment
ES		Extra Segment

	Flags
--	-------

<http://bucarotechelp.com/computers/architecture/86011201.asp>



1928

University of Technology

Intel 8086 assembly commands

```
mov x,y      ; x = y
xchg x,y     ; x <-> y
```

```
inc x        ; x++
dec x        ; x--
```

```
add x,y      ; x += y
sub x,y      ; x -= y
neg x        ; x = -x
```

; bitwise operators

```
and x,y      ; x = x & y
or x,y       ; x = x | y
xor x,y      ; x = x ^ y
not x        ; x = ~x
```

x, y: register, constant, memory (address)

General Purpose Registers

AX	AH	AL	Accumulator
BX	BH	BL	Base
CX	CH	CL	Count
DX	DH	DL	Data

Pointer and Index Registers

SP		Stack Pointer
BP		Base Pointer
SI		Source Index
DI		Destination Index
IP		Instruction Pointer

Segment Registers

CS		Code Segment
DS		Data Segment
SS		Stack Segment
ES		Extra Segment

	Flags
--	-------

<http://bucarotechelp.com/computers/architecture/86011201.asp>



1928

University of Technology

Intel 8086 assembly commands

assume *u*, *v* are memory locations (variables)

```
mov ax, bx
mov ax, 1
mov al, ah
mov cl, 123
mov ax, [u]
mov [v], bx
mov [v], 12

mov [v], [u]
```

General Purpose Registers

AX	AH	AL	Accumulator
BX	BH	BL	Base
CX	CH	CL	Count
DX	DH	DL	Data

Pointer and Index Registers

SP		Stack Pointer
BP		Base Pointer
SI		Source Index
DI		Destination Index
IP		Instruction Pointer

Segment Registers

CS		Code Segment
DS		Data Segment
SS		Stack Segment
ES		Extra Segment

	Flags
--	-------

<http://bucarotechelp.com/computers/architecture/86011201.asp>



1928

iversity of Technology

Intel 8086 assembly commands

assume *u, v* are memory locations (variables)

```
mov ax, bx
mov ax, 1
mov al, ah
mov cl, 123
mov ax, [u]
mov [v], bx
mov [v], 12
```

~~mov [v], [u]~~

General Purpose Registers

AX	AH	AL	Accumulator
BX	BH	BL	Base
CX	CH	CL	Count
DX	DH	DL	Data

Pointer and Index Registers

SP		Stack Pointer
BP		Base Pointer
SI		Source Index
DI		Destination Index
IP		Instruction Pointer

Segment Registers

CS		Code Segment
DS		Data Segment
SS		Stack Segment
ES		Extra Segment

	Flags
--	-------

<http://bucarotechelp.com/computers/architecture/86011201.asp>



1928

iversity of Technology

Intel 8086 assembly commands

assume *u, v* are memory locations (addresses)

```
mov ax, bx
mov ax, 1
mov al, ah
mov cl, 123
mov ax, [u]
mov [v], bx
mov [v], 12
```

```
mov [v], [u]
mov ax, [u]
mov [v], ax
```

General Purpose Registers

AX	AH	AL	Accumulator
BX	BH	BL	Base
CX	CH	CL	Count
DX	DH	DL	Data

Pointer and Index Registers

SP		Stack Pointer
BP		Base Pointer
SI		Source Index
DI		Destination Index
IP		Instruction Pointer

Segment Registers

CS		Code Segment
DS		Data Segment
SS		Stack Segment
ES		Extra Segment

	Flags
--	-------

<http://bucarotechelp.com/computers/architecture/86011201.asp>



1928

iversity of Technology

Intel 8086 assembly commands

assume *u*, *v* are memory locations (variables)

```
add ax, bx
```

```
add ax, 1
```

```
add al, ah
```

```
add cl, 123
```

```
add ax, [u]
```

```
add [v], bx
```

```
add [v], 12
```

```
add [v], [u]
```

General Purpose Registers

AX	AH	AL	Accumulator
BX	BH	BL	Base
CX	CH	CL	Count
DX	DH	DL	Data

Pointer and Index Registers

SP		Stack Pointer
BP		Base Pointer
SI		Source Index
DI		Destination Index
IP		Instruction Pointer

Segment Registers

CS		Code Segment
DS		Data Segment
SS		Stack Segment
ES		Extra Segment

		Flags
--	--	-------

<http://bucarotechelp.com/computers/architecture/86011201.asp>



1928

University of Technology

Intel 8086 assembly commands

assume *u*, *v* are memory locations (variables)

```
add ax, bx
add ax, 1
add al, ah
add cl, 123
add ax, [u]
add [v], bx
add [v], 12
```

~~add [v], [u]~~

General Purpose Registers

AX	AH	AL	Accumulator
BX	BH	BL	Base
CX	CH	CL	Count
DX	DH	DL	Data

Pointer and Index Registers

SP		Stack Pointer
BP		Base Pointer
SI		Source Index
DI		Destination Index
IP		Instruction Pointer

Segment Registers

CS		Code Segment
DS		Data Segment
SS		Stack Segment
ES		Extra Segment

		Flags
--	--	-------

<http://bucarotechelp.com/computers/architecture/86011201.asp>



1928

University of Technology

Intel 8086 assembly commands

assume *u, v* are memory locations (variables)

```
add ax, bx
add ax, 1
add al, ah
add cl, 123
add ax, [u]
add [v], bx
add [v], 12
```

~~add [v], [u]~~

```
mov ax, [u]
```

```
add [v], ax
```

General Purpose Registers

AX	AH	AL	Accumulator
BX	BH	BL	Base
CX	CH	CL	Count
DX	DH	DL	Data

Pointer and Index Registers

SP		Stack Pointer
BP		Base Pointer
SI		Source Index
DI		Destination Index
IP		Instruction Pointer

Segment Registers

CS		Code Segment
DS		Data Segment
SS		Stack Segment
ES		Extra Segment

	Flags
--	-------

<http://bucarotechelp.com/computers/architecture/86011201.asp>



1928

University of Technology

Intel 8086 assembly commands

; bx = (ax-10)*2

; ax = (ax+1)*8

; ax = (ax-1)*9

General Purpose Registers

AX	AH	AL	Accumulator
BX	BH	BL	Base
CX	CH	CL	Count
DX	DH	DL	Data

Pointer and Index Registers

SP		Stack Pointer
BP		Base Pointer
SI		Source Index
DI		Destination Index
IP		Instruction Pointer

Segment Registers

CS		Code Segment
DS		Data Segment
SS		Stack Segment
ES		Extra Segment

	Flags
--	-------

<http://bucarotechelp.com/computers/architecture/86011201.asp>



1928

University of Technology

Intel 8086 assembly commands

```
; bx = (ax-10)*2
```

```
mov bx, ax
```

```
sub bx, 10
```

```
add bx, bx
```

```
; ax = (ax+1)*8
```

```
inc ax
```

```
add ax, ax
```

```
add ax, ax
```

```
add ax, ax
```

```
; ax = (ax-1)*9
```

```
dec ax
```

```
mov si, ax
```

```
add ax, ax
```

```
add ax, ax
```

```
add ax, ax
```

```
add ax, si
```

General Purpose Registers

AX	AH	AL	Accumulator
BX	BH	BL	Base
CX	CH	CL	Count
DX	DH	DL	Data

Pointer and Index Registers

SP		Stack Pointer
BP		Base Pointer
SI		Source Index
DI		Destination Index
IP		Instruction Pointer

Segment Registers

CS		Code Segment
DS		Data Segment
SS		Stack Segment
ES		Extra Segment

	Flags
--	-------

<http://bucarotechelp.com/computers/architecture/86011201.asp>



80386 (IA-32, i386)

EAX		AH	AX	AL	Accumulator
EBX		BH	BX	BL	Base Index
ECX		CH	CX	CL	Count
EDX		DH	DX	DL	Data
ESP			SP		Stack Pointer
EBP			BP		Base Pointer
EDI			DI		Destination Index
ESI			SI		Source Index
EIP			IP		Instruction Pointer
EFLAGS			FLAGS		Flags
			CS		Code
			DS		Data
			ES		Extra
			SS		Stack
			FS		
			GS		

Figure 2-1 : The programming model of the microprocessor.

http://www.byclb.com/TR/Tutorials/microprocessors/ch2_1.htm



1928

Foosi University of Technology

8086, 80286

General Purpose Registers

AX	AH	AL	Accumulator
BX	BH	BL	Base
CX	CH	CL	Count
DX	DH	DL	Data

Pointer and Index Registers

SP		Stack Pointer
BP		Base Pointer
SI		Source Index
DI		Destination Index
IP		Instruction Pointer

Segment Registers

CS		Code Segment
DS		Data Segment
SS		Stack Segment
ES		Extra Segment
		Flags

<http://bucarotechelp.com/computers/architecture/86011201.asp>

64 bit x86 systems (x86-64)



1928

K. N. Toosi University of Technology

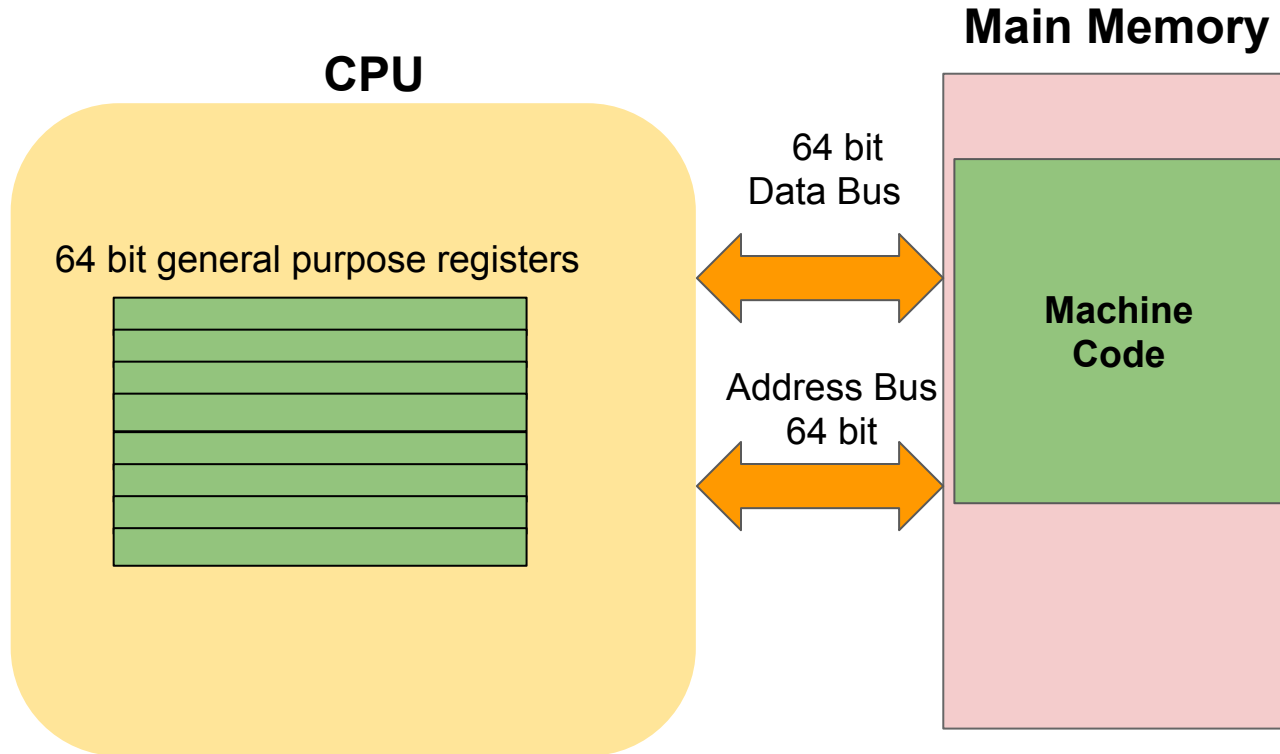

x86-64 bit registers



1928

K. N. Toosi University of Technology

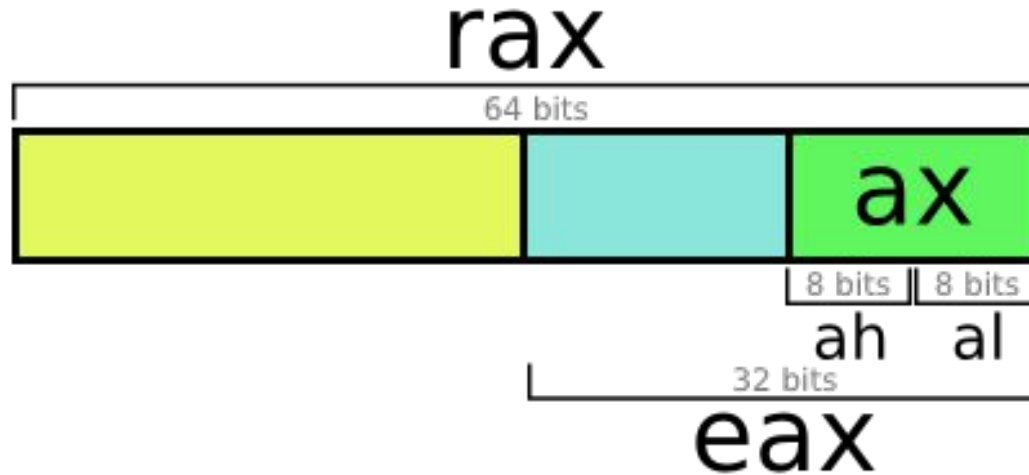

<http://nullprogram.com/blog/2015/05/15/>



x86-64 bit registers (x86-64, AMD64, Intel64, x64)

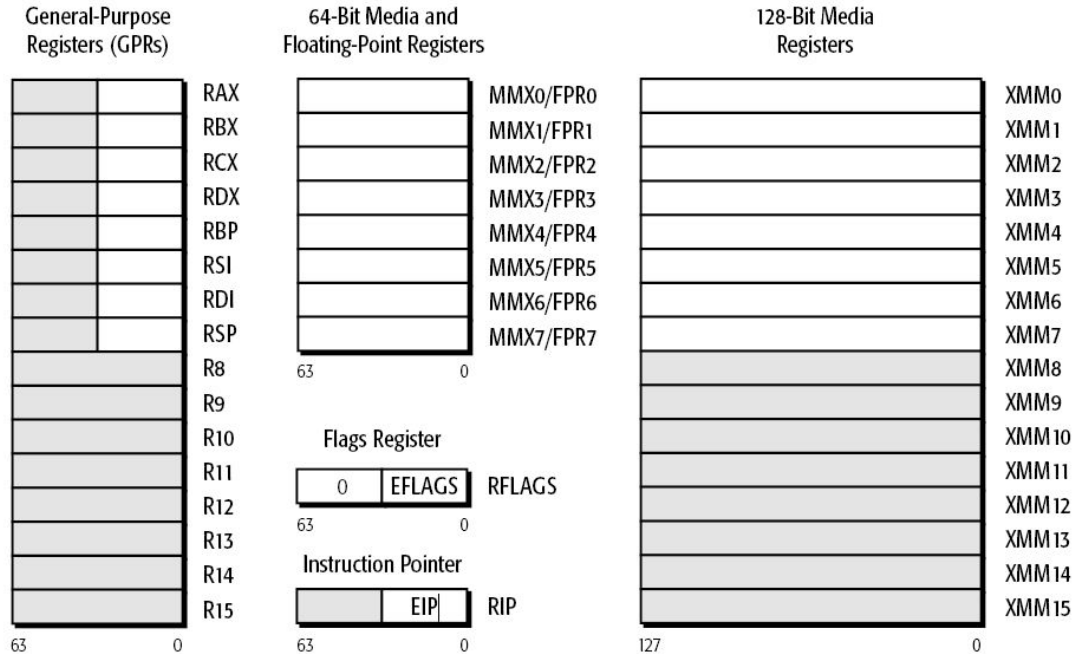

1928

K. N. Toosi University of Technology



 Legacy x86 registers, supported in all modes
 Register extensions, supported in 64-bit mode

Application-programming registers also include the 128-bit media control-and-status register and the x87 tag-word, control-word, and status-word registers

<https://www.viva64.com/en/a/0029/>